



■ AC Plug Type

AC plug type	2 pin Euro	2 pin USA	2 Pin China	3 pin UK	2 pin AU	2 pin JP	2 pin KR	2 pin AR
Shape No.	K12E-USB	K12U-USB	K12C-USB	K12B-USB	K12S-USB	K12J-USB	K12K-USB	K12R-USB

■ Features

- Universal AC input Full range
- 2 pole US, EU, AU/NZ, EK, JP, AR,CN and 3 pole UK plug, Class II power unit
- No load power consumption < 0.1W
- Energy efficiency Level VI
- Comply with EISA 2007 / DoE and NRCAN
- Protections: Short circuit / Overload / Over voltage
- Fully enclosed plastic case
- 00~ +40°C wide range working temperature



■ Applications

- Consumer electronic devices
- Telecommunication devices
- Office facilities
- Industrial equipment



■ Description

K12x is a highly reliable, 12W wall-mounted style single-output USB adaptor series. This product is a class II power unit (no FG), equipped with standard AC power plug, adopting the input range from 90VAC to 264VAC. The entire series supplies different models with output voltages ranging between 5VDC that can satisfy the demands for various types of consumer electronic devices.

■ Mechanical Characteristics

- see below Dimension Diagrams
- Weight: 60g (2.65oz)

■ **Characteristics**

Input:

AC Input Voltage Rating

100 to 240VAC

AC Input Voltage Range

90 to 264VAC

AC Input Frequency

47 to 63Hz

Input Current

0.5A (RMS) maximum at 120VAC 0.25A (RMS) maximum at 240VAC

Leakage Current

0.25A maximum at 264VAC

Inrush Current (Cold Start at ambient 25° C)

30A for 120VAC and maximum load 60A for 240VAC at maximum load

Input Power Saving

0.1W maximum at no load

Output: Efficiency

Meet energy saving efficiency level VI.

Hold-up Time

10mS minimum at 120VAC and maximum load

Short-Circuit Protection

Auto restart

Environmental Temperature

Operation 0 to +40° C

Non-operation -40 to +85° C

Humidity 10-90% non-condensing

Emissions

Complies with FCC Class B Complies with EN55032 Class B

Immunity

AN/NZS CISPR22

EN55024 J55022(H22)

EN61000-4-2 Level EN61000-4-3 Level

EN61000-4-4 Level EN61000-4-5 Level

EN61000-4-6 Level EN61000-4-8 Level

EN61000-4-11 Level EN61000-3-2 Level

EN61000-3-3 Level

GB9254+GB1762

Dielectric Withstand (Hi-pot) Test Primary to Secondary:

3500V AC for 1 min., 10mA

Primary to F.G.: 1500V AC for 1 min., 10mA

DC Output Connector

2.1 x 5.5mm Center Positive+ Standard or Usb equivalent,

Or see [KRE-connectors-Spec.pdf](#)

Output Cable

USB main, or 1.5 meter (4.92 feet), UL2468, from 24-18AWG guage or equivalent

Mating Connector

Equivalent

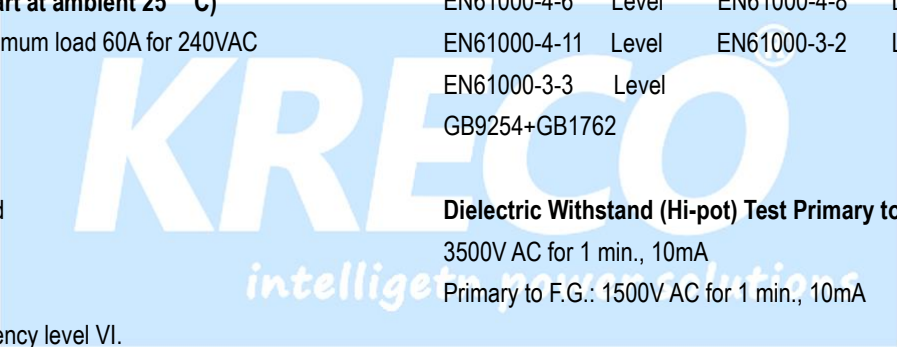

■ Output Specifications

KRECO P/N (see note)	DC Output Voltage	Load		Output Power	Safety Approvals	Energy Saving Level	Standards
		Min	Max				
KRE006SPS-xxxxyyzf or KRE-xxxxyyZ or DK15-XXX-YYYY	5V	0.01A	2.1A	10.5W max	CCC/CQC	V&VI	GB8898

■ Dimension Diagram for K12C-USB

Unit:mm

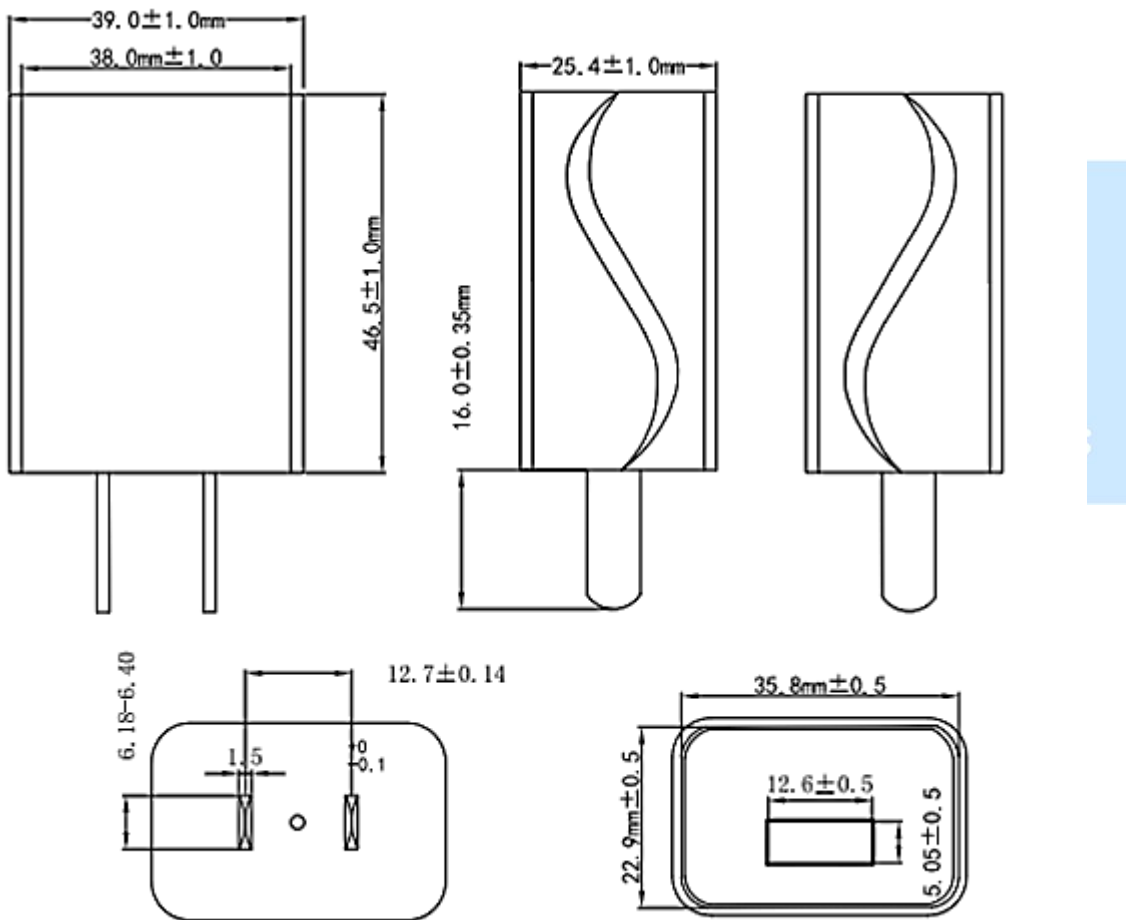

Dimension Diagram for K12E-USB Unit:mm

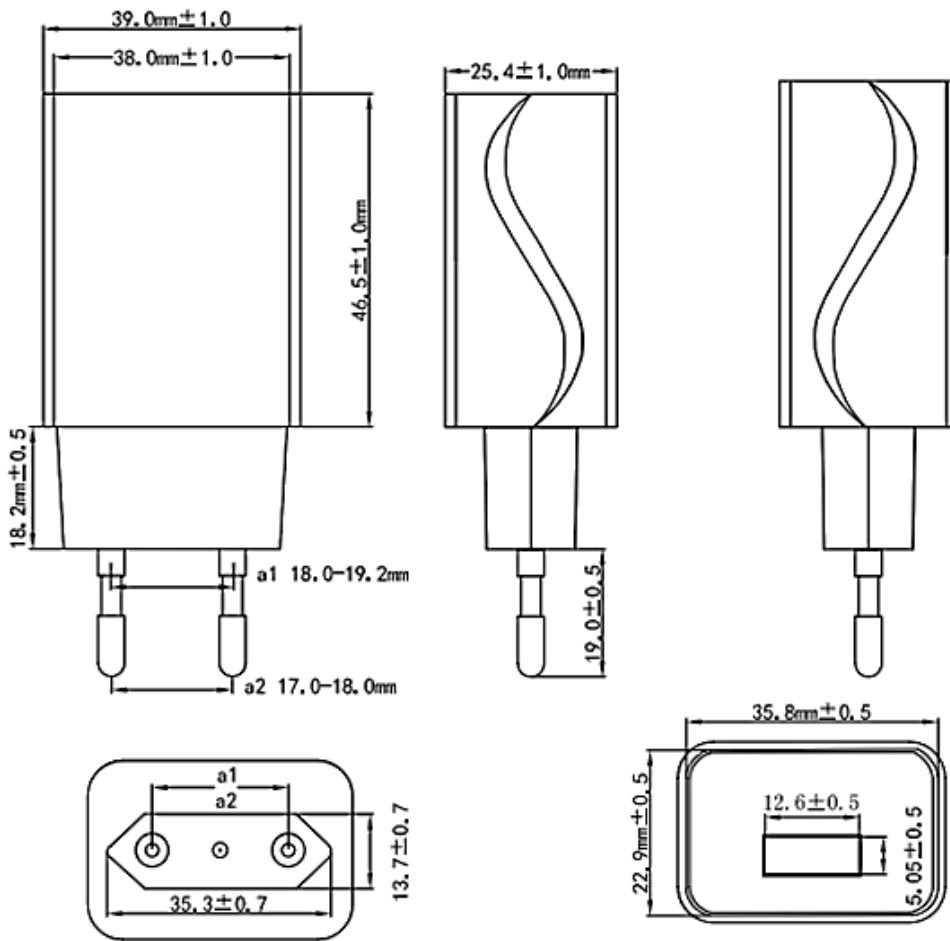

intelligent power solutions

■ Dimension Diagram for K12U-USB or K12J-USB (2styles) Unit:mm

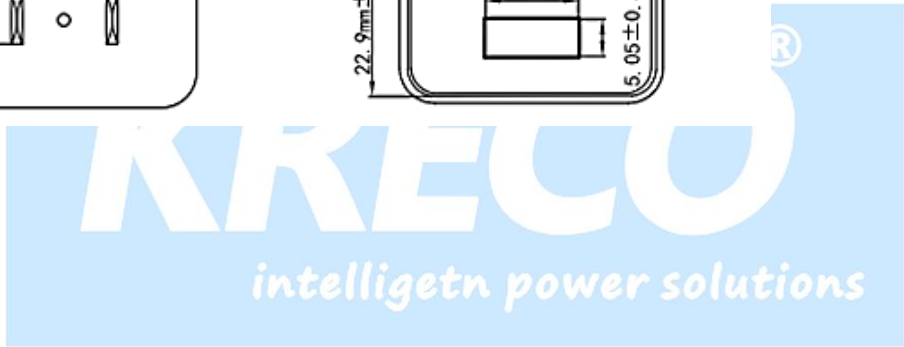
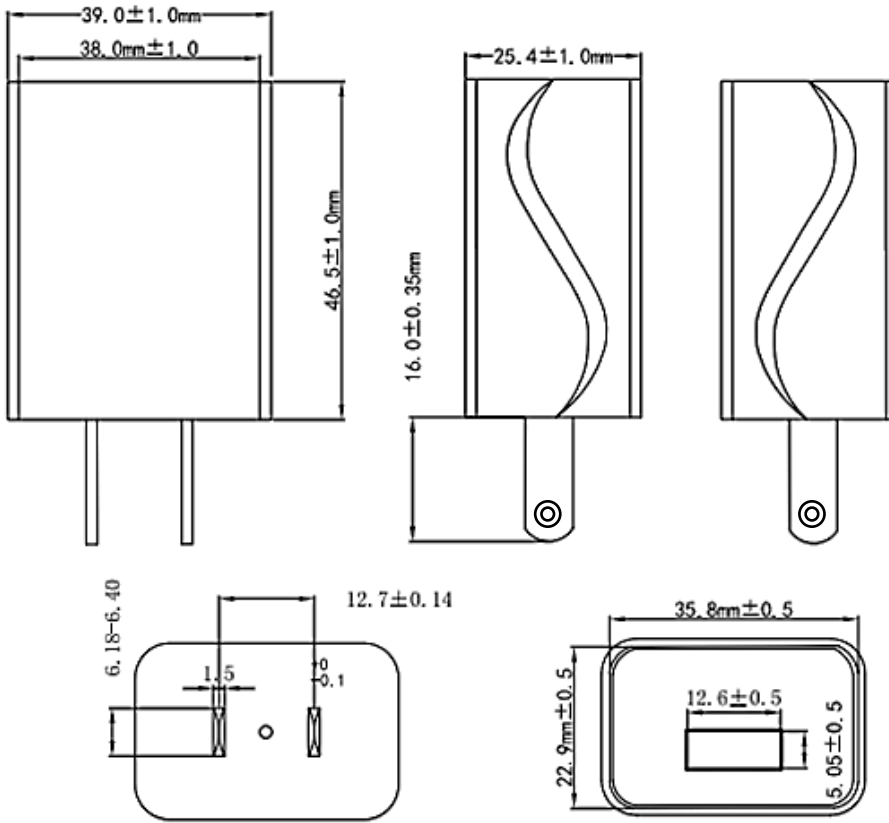

■ Dimension Diagram for K12S-USB

Unit:mm

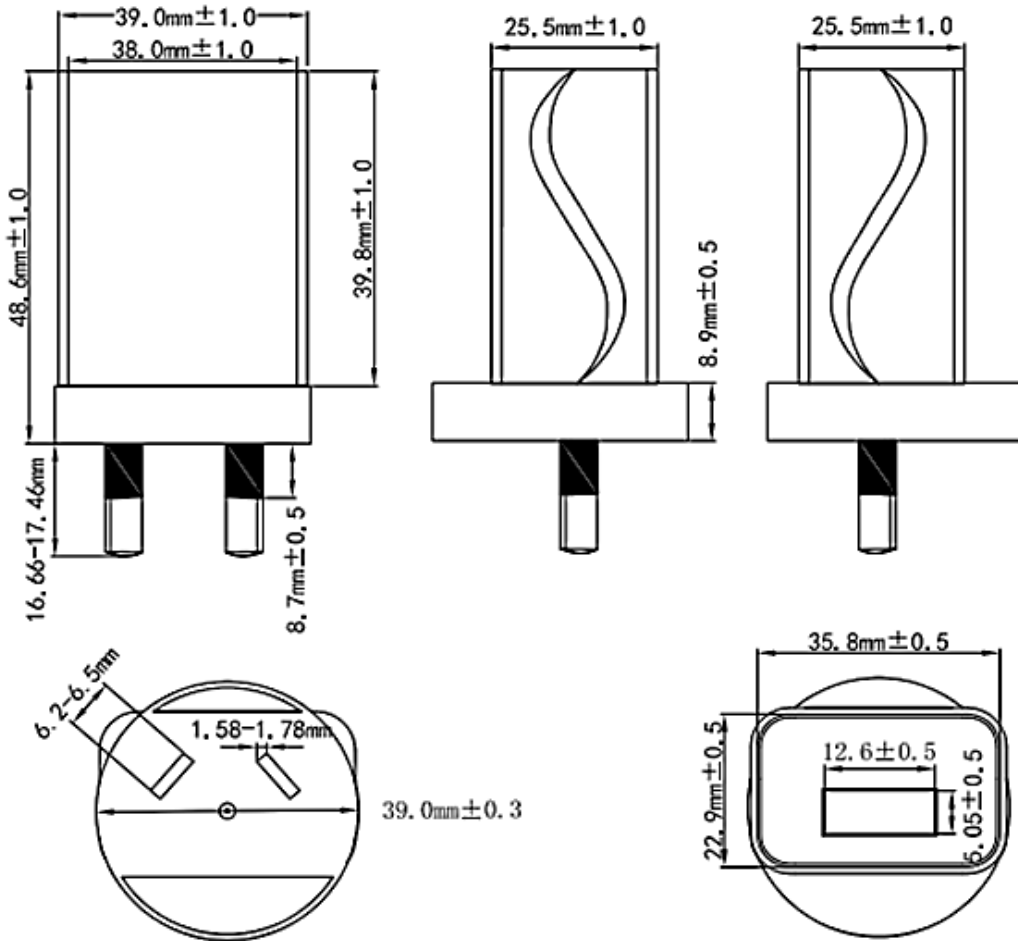

Dimension Diagram for K12B-USB

Unit:mm

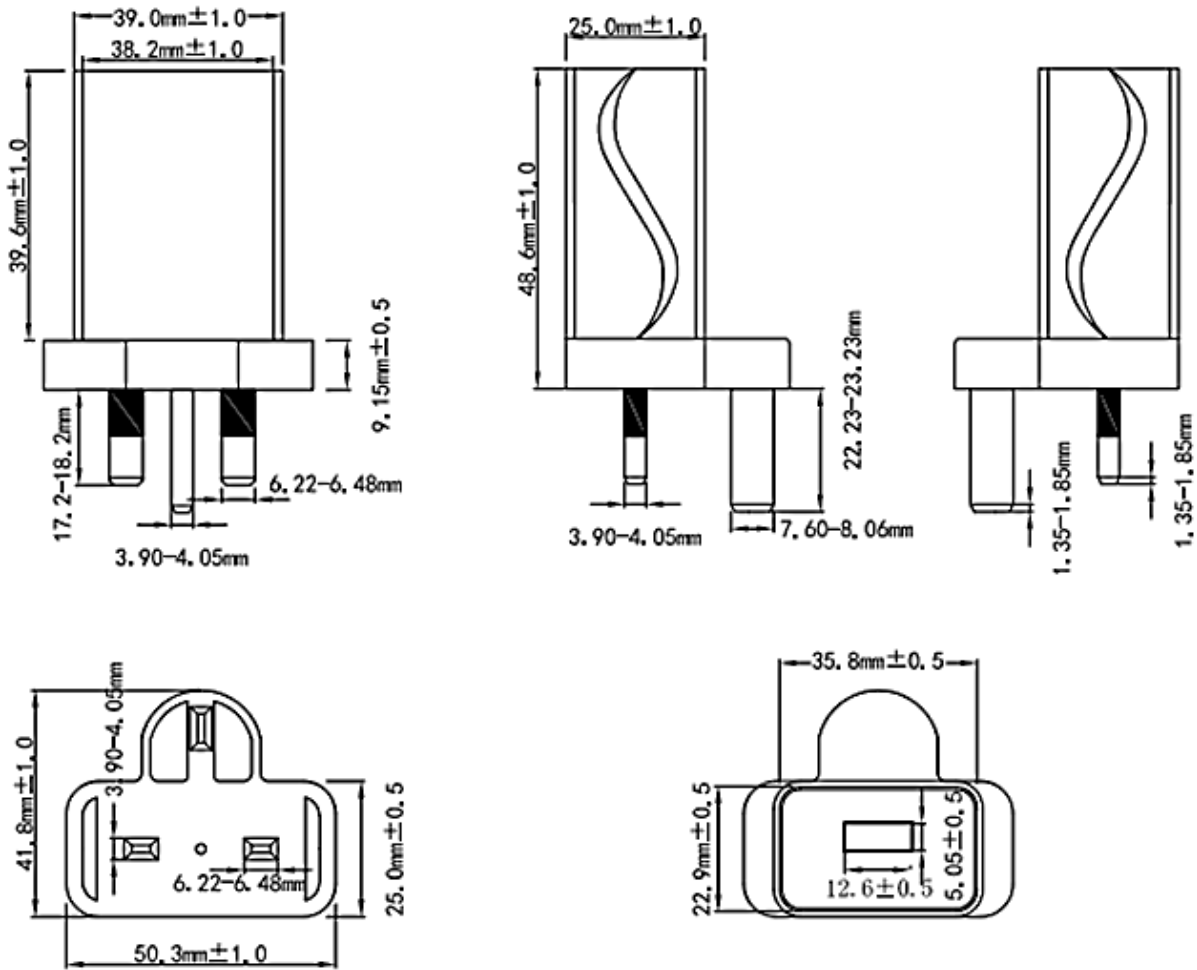

- (1) X = E for EU version, U for US version, C for Chinese version, B for UK version, S for Australian version, J for Japanes version, K for South Korea version, R for Argentina version, Z for South Africa (3 Big pins) version, I for Interchangeable version,
- (2) xxx for Output voltage and yyy for output current, what you are going to order, please must specify to sales.
- (3) Safety approvals according to the AC plug type, which is different from each other.
- (4) Safety model number differs from the order number, part number, and shape number as per respective OEM/ODM factories.

Kreco is not responsible for any error, and reserves the right to make changes without notice. Please visit our website at www.kreco.com.cn for the most up-to-date specifications and contact information.